

Garland R-MER CLAD Built-Up System Roof

Bracket Height	Insulation Thickness	Insulation Value	Overall System Depth	U Value at 1.5M Centres	Nominal Weight/M ²
100mm	100mm	0.040 λ	133mm	0.48	15.86kg/m ²
120mm	120mm	0.040 λ	153mm	0.40	16.12kg/m ²
185mm	200mm	0.040 λ	218mm	0.25	17.14kg/m ²
200mm	200mm	0.040 λ	233mm	0.23	17.16kg/m ²
220mm	220mm	0.040 λ	253mm	0.21	17.42kg/m ²
240mm	240mm	0.040 λ	273mm	0.19	17.68kg/m ²
260mm	260mm	0.040 λ	293mm	0.18	17.94kg/m ²
280mm	280mm	0.040 λ	313mm	0.16	18.20kg/m ²
300mm	300mm	0.040 λ	333mm	0.15	18.46kg/m ²
320mm	320mm	0.040 λ	353mm	0.14	18.72kg/m ²

Minimum recommended pitch 4°

SITE:

DRAWING NO.

PROJECT NO.

09/04/2020
DATE.



The Garland Company UK Limited
Second Way, Avonmouth, Bristol, BS11 8DF
Tel: 01174 401050 Fax: 01174 401057
www.garlandukltd.co.uk

TITLE:

R-MER CLAD BUILT-UP ROOF SYSTEM

NTS
SCALE AT A4.

MF
DRAWN.

-
CHECKED.

1.0
REVISION.

NOTE: THIS DRAWING IS FOR GUIDANCE AND REFERENCE ONLY.
TO BE USED IN CONJUNCTION WITH SPECIFICATION.

R-MER CLAD BUILT-UP ROOF SIDE LAP DETAIL

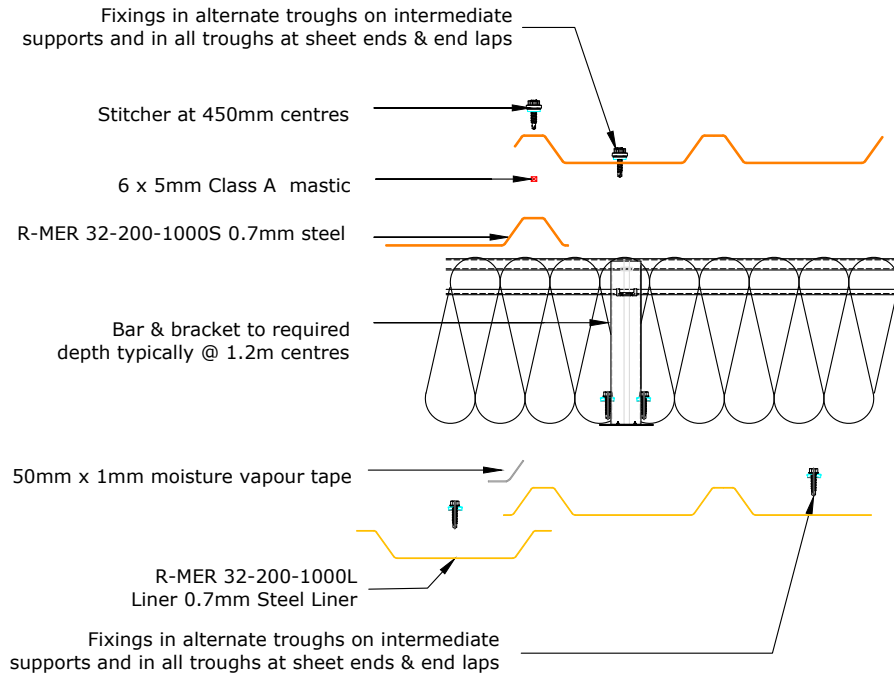

R-MER CLAD BUILT-UP ROOF END LAP DETAIL

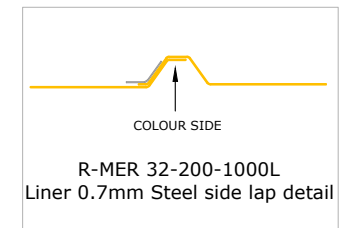
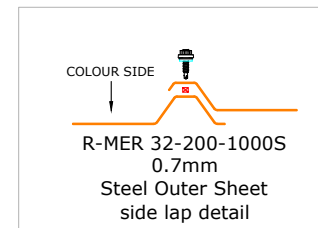
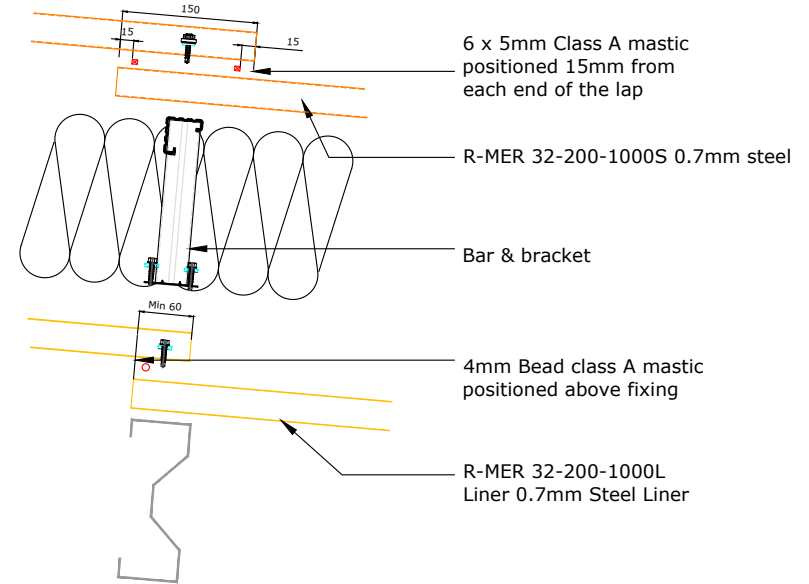

SITE:

DRAWING NO.

PROJECT NO.

09/04/2020
DATE.



The Garland Company UK Limited
Second Way, Avonmouth, Bristol, BS11 8DF
Tel: 01174 401050 Fax: 01174 401057
www.garlandukltd.co.uk

TITLE:

R-MER CLAD BUILT-UP ROOF SYSTEM - EXPLODED

NTS
SCALE AT A4.

MF
DRAWN.

-
CHECKED.

1.0
REVISION.

NOTE: THIS DRAWING IS FOR GUIDANCE AND REFERENCE ONLY.
TO BE USED IN CONJUNCTION WITH SPECIFICATION.

R-MER 32-200-1000 0.7mm EXTERNAL SHEET

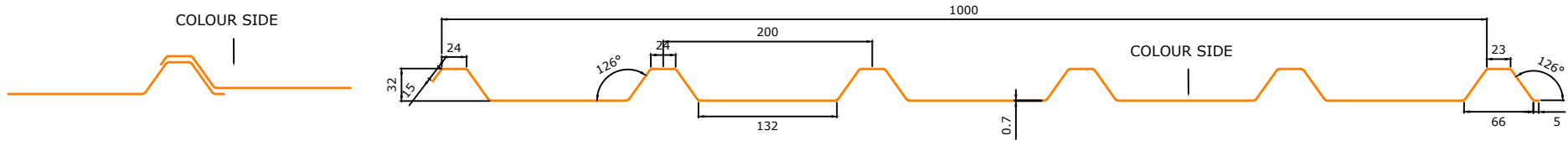

R-MER 32-200-1000L 0.7mm LINER SHEET

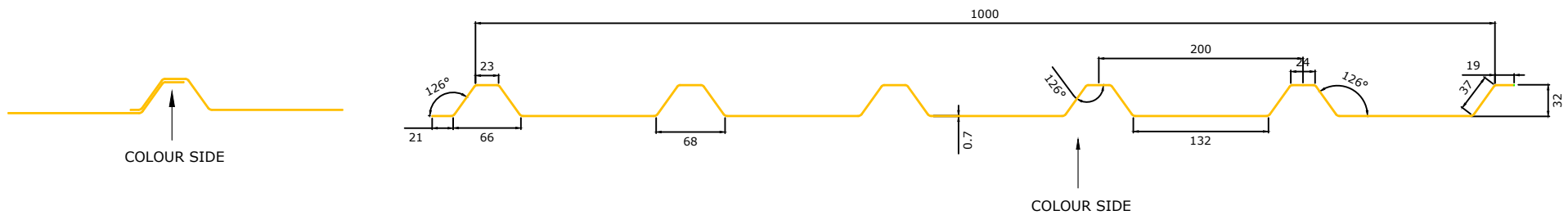

SITE:	DRAWING NO.		- PROJECT NO.	09/04/2020 DATE.		The Garland Company UK Limited Second Way, Avonmouth, Bristol, BS11 8DF Tel: 01174 401050 Fax: 01174 401057 www.garlandukltd.co.uk
TITLE: R-MER CLAD BUILT-UP ROOF SYSTEM - PROFILES	NTS SCALE AT A4.	MF DRAWN.	- CHECKED.	1.0 REVISION.		NOTE: THIS DRAWING IS FOR GUIDANCE AND REFERENCE ONLY. TO BE USED IN CONJUNCTION WITH SPECIFICATION.

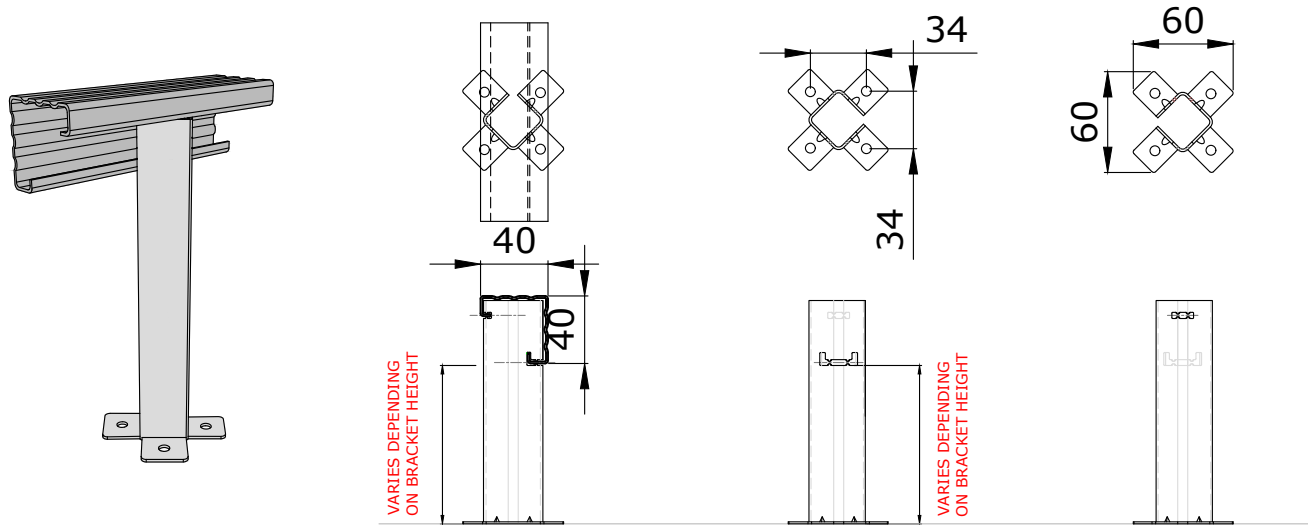

Brackets less than 260mm require 2 fixings diagonally opposite.
 Brackets 260mm or more require 4 fixings.

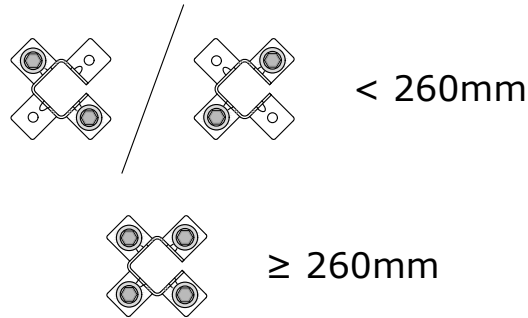

SITE:	DRAWING NO.		-	09/04/2020		The Garland Company UK Limited Second Way, Avonmouth, Bristol, BS11 8DF Tel: 01174 401050 Fax: 01174 401057 www.garlandukltd.co.uk
	TITLE:	NTS SCALE AT A4.	MF DRAWN.	- CHECKED.		
R-MER CLAD BUILT-UP ROOF SYSTEM - BRACKET						NOTE: THIS DRAWING IS FOR GUIDANCE AND REFERENCE ONLY. TO BE USED IN CONJUNCTION WITH SPECIFICATION.

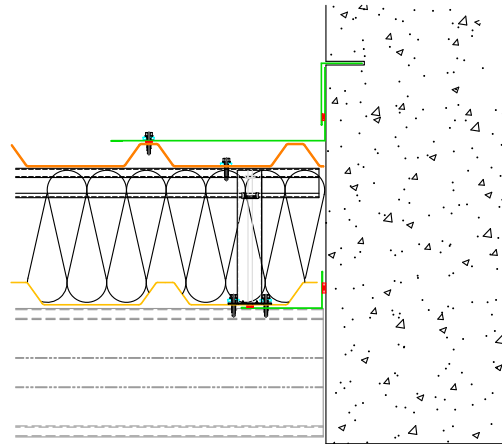

R-MER CLAD BUILT-UP SYSTEM ROOF CONSTRUCTION

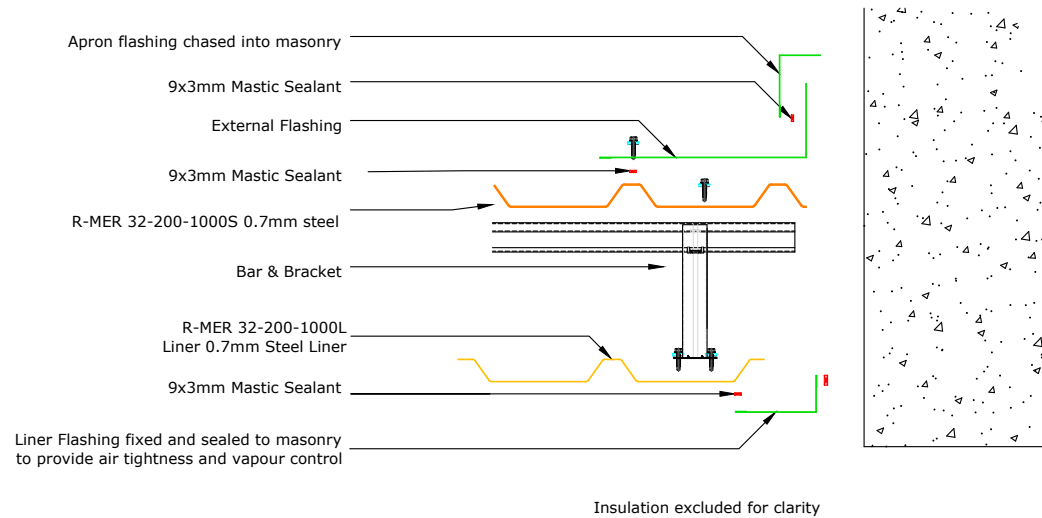

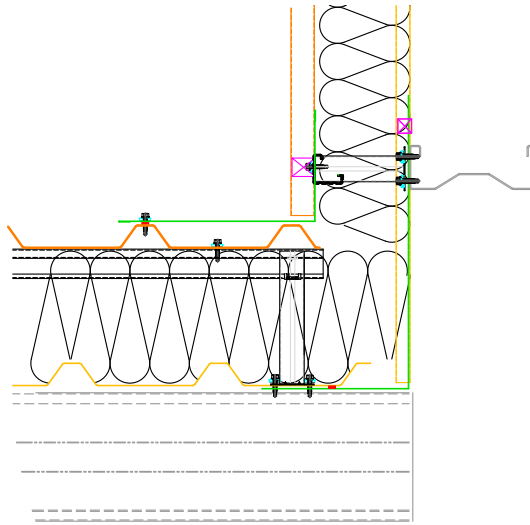

SITE:	DRAWING NO.		PROJECT NO.	DATE.		The Garland Company UK Limited Second Way, Avonmouth, Bristol, BS11 8DF Tel: 01174 401050 Fax: 01174 401057 www.garlandukltd.co.uk
TITLE: R-MER CLAD BUILT-UP ROOF SYSTEM - ABUTMENT WALL	NTS SCALE AT A4.	MF DRAWN.	- CHECKED.	09/04/2020 1.0 REVISION.		NOTE: THIS DRAWING IS FOR GUIDANCE AND REFERENCE ONLY. TO BE USED IN CONJUNCTION WITH SPECIFICATION.

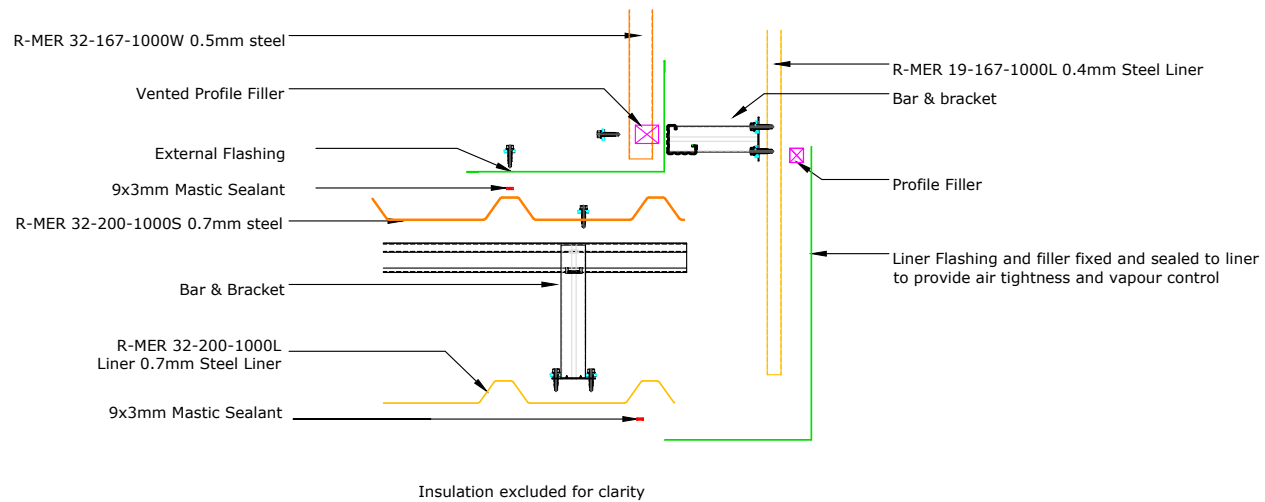

R-MER CLAD BUILT-UP SYSTEM ROOF CONSTRUCTION

R-MER CLAD BUILT-UP SYSTEM WALL V 1 CONSTRUCTION



SITE:	DRAWING NO.		PROJECT NO.	DATE.	 The Garland Company UK Limited Second Way, Avonmouth, Bristol, BS11 8DF Tel: 01174 401050 Fax: 01174 401057 www.garlandukltd.co.uk
	09/04/2020				
TITLE:	NTS	MF	-	1.0	NOTE: THIS DRAWING IS FOR GUIDANCE AND REFERENCE ONLY. TO BE USED IN CONJUNCTION WITH SPECIFICATION.
R-MER CLAD BUILT-UP ROOF SYSTEM - ABUTMENT CLADDING	SCALE AT A4.	DRAWN.	CHECKED.	REVISION.	

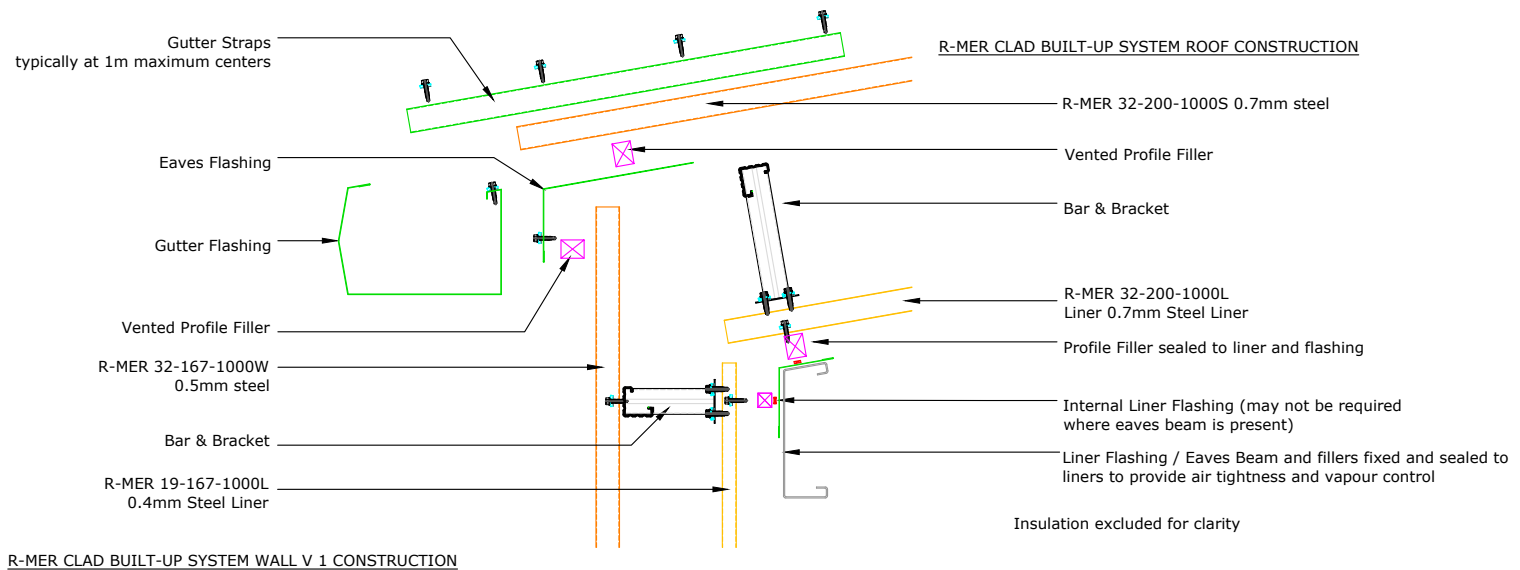
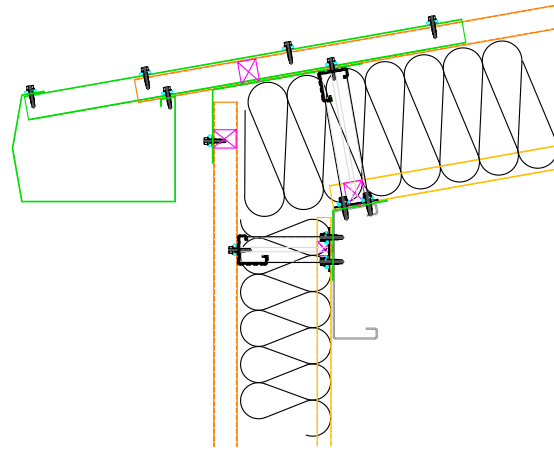

SITE:

DRAWING NO.

PROJECT NO.

09/04/2020

DATE.



The Garland Company UK Limited
 Second Way, Avonmouth, Bristol, BS11 8DF
 Tel: 01174 401050 Fax: 01174 401057
 www.garlandukltd.co.uk

TITLE:

R-MER CLAD BUILT-UP ROOF SYSTEM - EAVES GUTTER

NTS
 SCALE AT A4.

MF
 DRAWN.

-
 CHECKED.

1.0
 REVISION.

NOTE: THIS DRAWING IS FOR GUIDANCE AND REFERENCE ONLY.
 TO BE USED IN CONJUNCTION WITH SPECIFICATION.

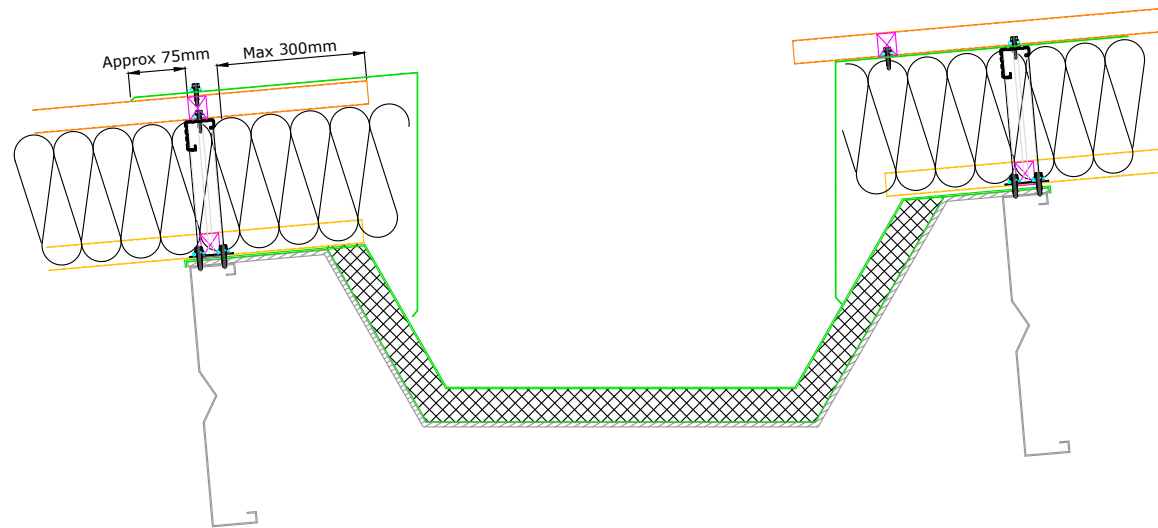

R-MER CLAD BUILT-UP SYSTEM ROOF CONSTRUCTION

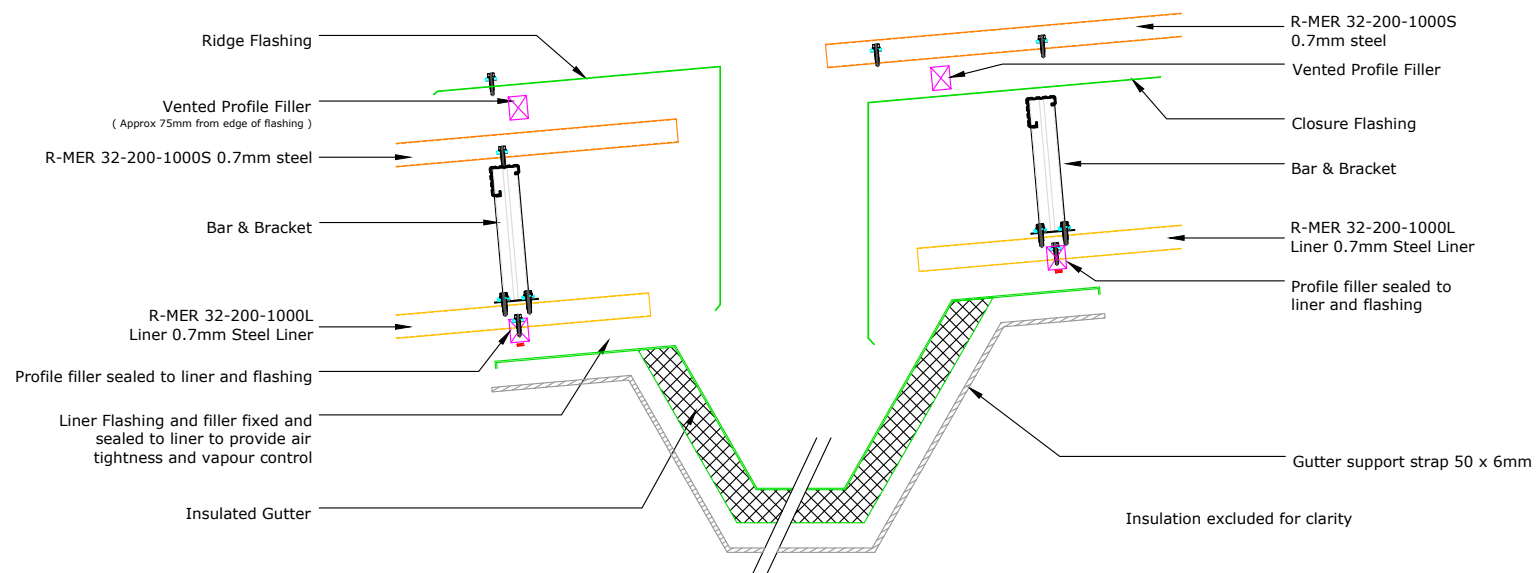

SITE: 	DRAWING NO. 		- PROJECT NO. 	09/04/2020 DATE. 		The Garland Company UK Limited Second Way, Avonmouth, Bristol, BS11 8DF Tel: 01174 401050 Fax: 01174 401057 www.garlandukltd.co.uk
TITLE: R-MER CLAD BUILT-UP ROOF SYSTEM - SECRET GUTTER	NTS SCALE AT A4.	MF DRAWN.	- CHECKED.	1.0 REVISION.		NOTE: THIS DRAWING IS FOR GUIDANCE AND REFERENCE ONLY. TO BE USED IN CONJUNCTION WITH SPECIFICATION.

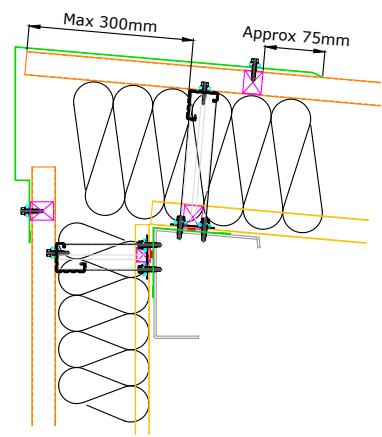

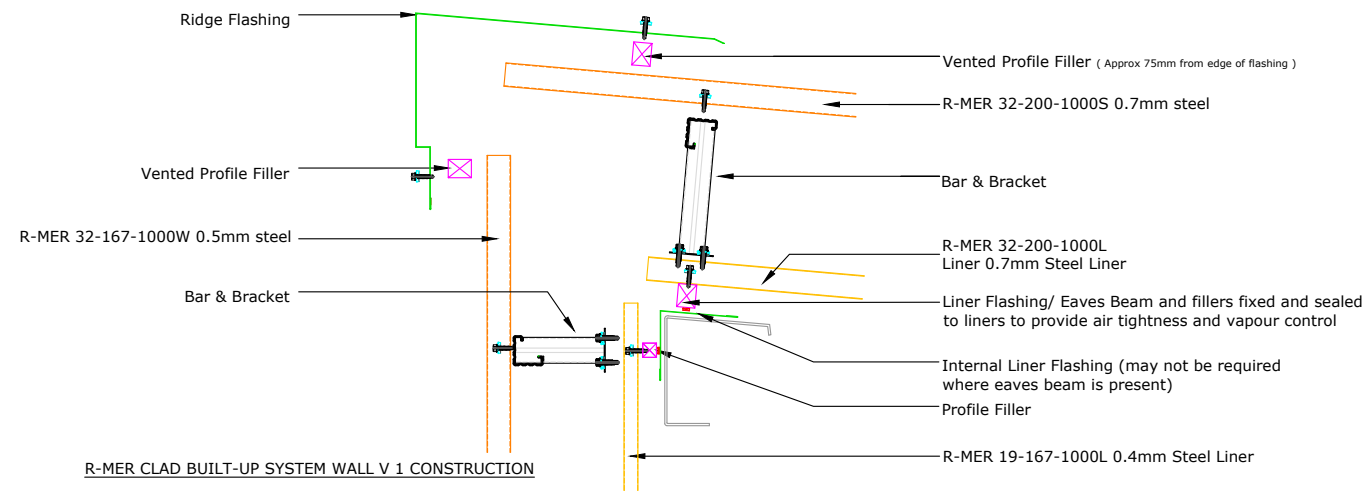

R-MER CLAD BUILT-UP SYSTEM ROOF CONSTRUCTION

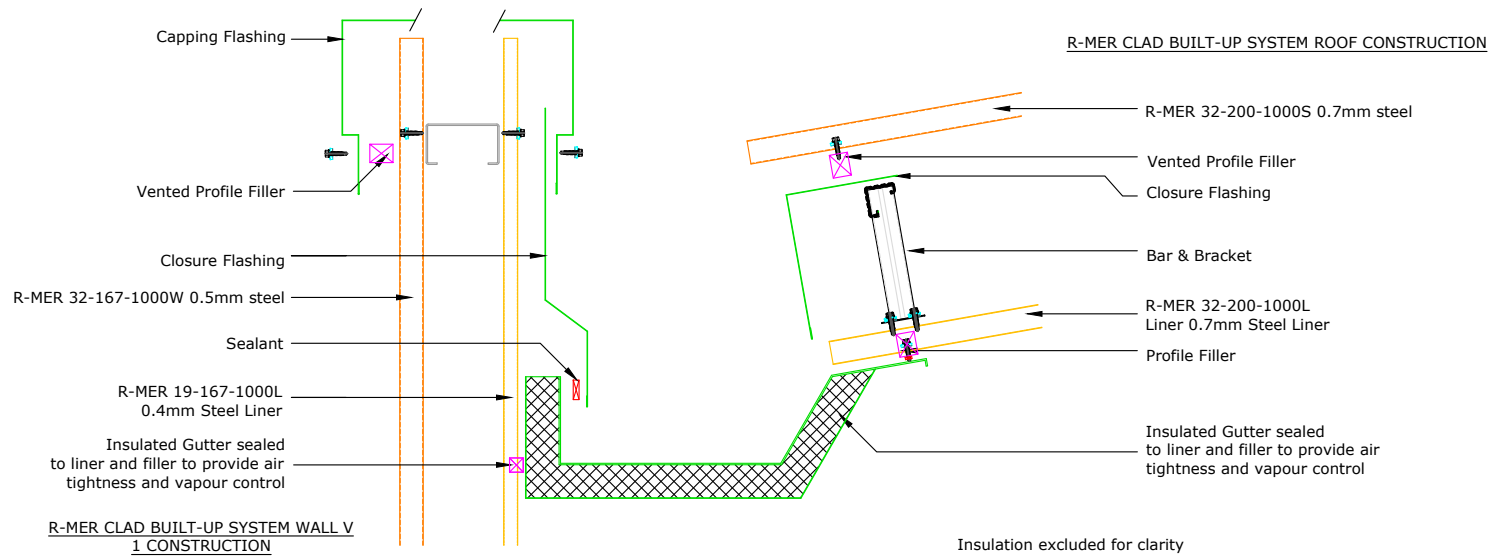
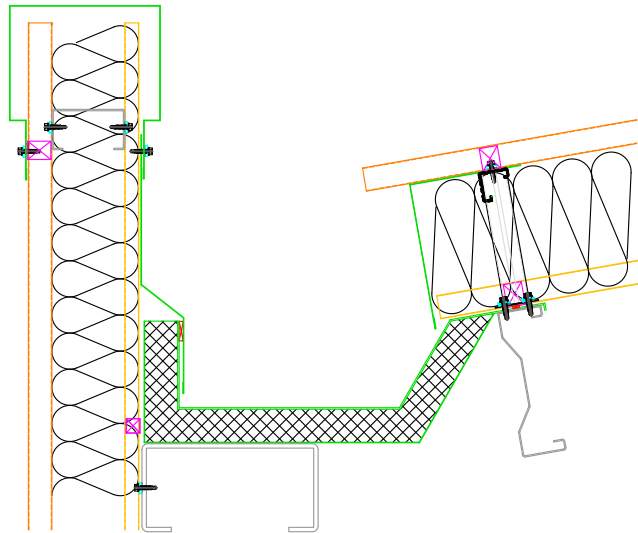

Insulation excluded for clarity

SITE:	DRAWING NO.	-	PROJECT NO.	09/04/2020		The Garland Company UK Limited Second Way, Avonmouth, Bristol, BS11 8DF Tel: 01174 401050 Fax: 01174 401057 www.garlandukltd.co.uk
TITLE: R-MER CLAD BUILT-UP ROOF SYSTEM - MONO RIDGE	NTS SCALE AT A4.	MF DRAWN.	-	1.0 REVISION.		NOTE: THIS DRAWING IS FOR GUIDANCE AND REFERENCE ONLY. TO BE USED IN CONJUNCTION WITH SPECIFICATION.



SITE:	DRAWING NO. NTS		PROJECT NO. -	DATE. 09/04/2020		The Garland Company UK Limited Second Way, Avonmouth, Bristol, BS11 8DF Tel: 01174 401050 Fax: 01174 401057 www.garlandukltd.co.uk
TITLE: R-MER CLAD BUILT-UP ROOF SYSTEM - PARAPET GUTTER	SCALE AT A4.	MF DRAWN.	CHECKED. -	REVISION. 1.0		NOTE: THIS DRAWING IS FOR GUIDANCE AND REFERENCE ONLY. TO BE USED IN CONJUNCTION WITH SPECIFICATION.

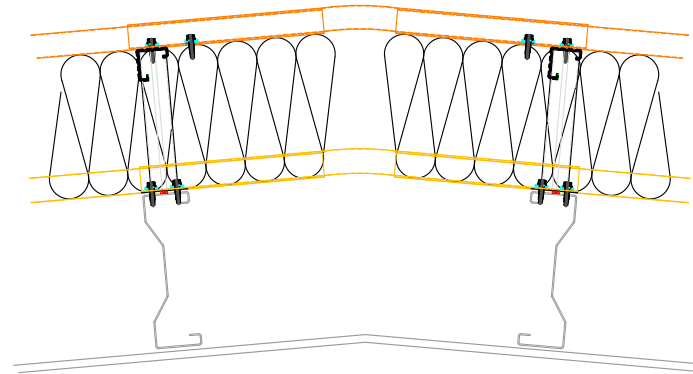
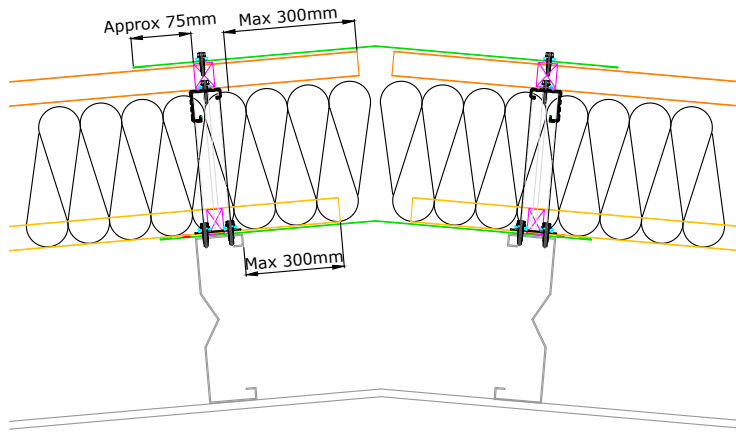

R-MER CLAD BUILT-UP SYSTEM ROOF CONSTRUCTION

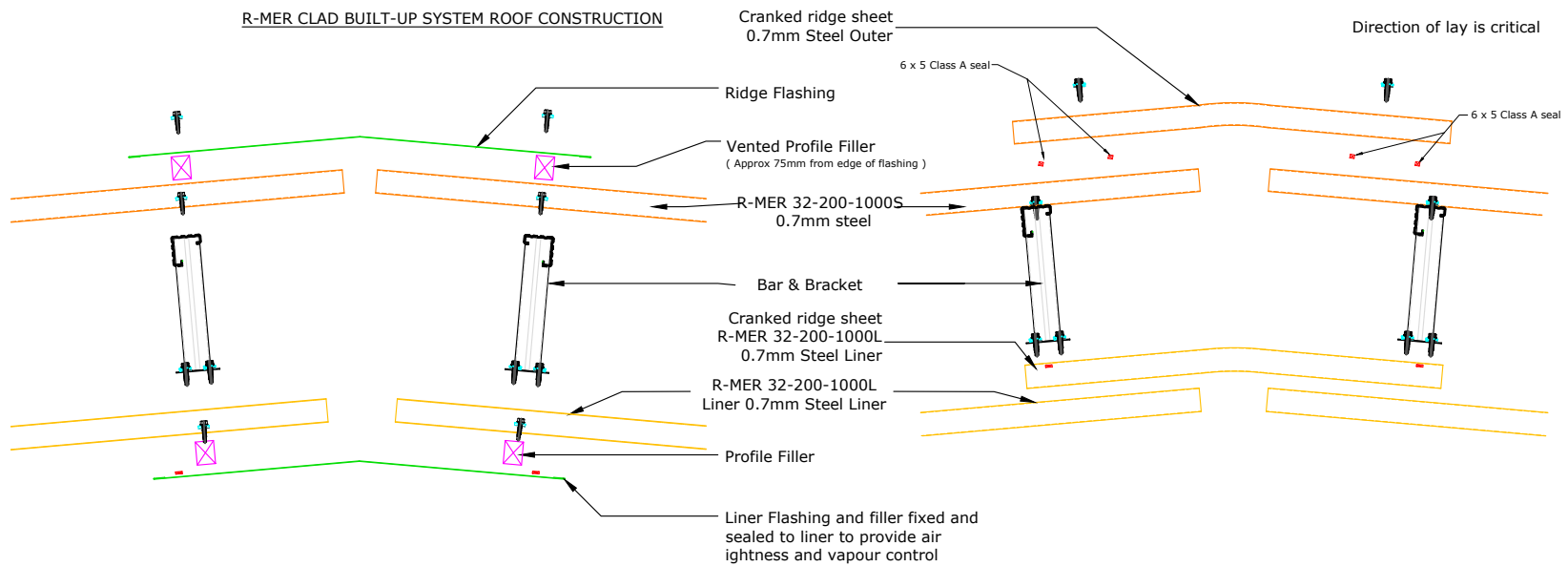

SITE:

DRAWING NO.

PROJECT NO.

09/04/2020

DATE.



The Garland Company UK Limited
 Second Way, Avonmouth, Bristol, BS11 8DF
 Tel: 01174 401050 Fax: 01174 401057
 www.garlandukltd.co.uk

TITLE:

R-MER CLAD BUILT-UP ROOF SYSTEM - RIDGE

NTS
 SCALE AT A4.

MF
 DRAWN.

-
 CHECKED.

1.0
 REVISION.

NOTE: THIS DRAWING IS FOR GUIDANCE AND REFERENCE ONLY.
 TO BE USED IN CONJUNCTION WITH SPECIFICATION.

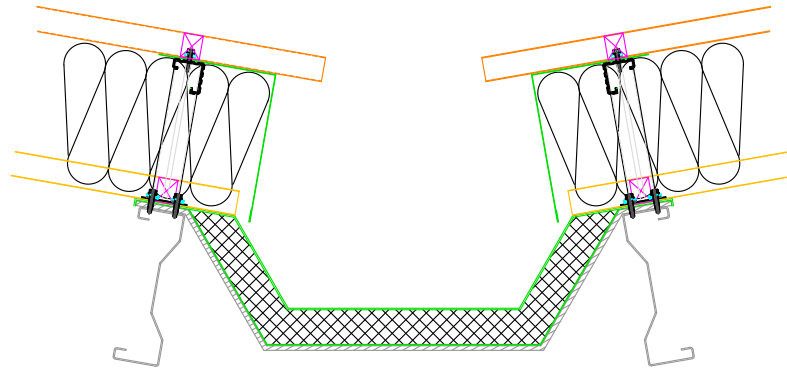

R-MER CLAD BUILT-UP SYSTEM ROOF CONSTRUCTION

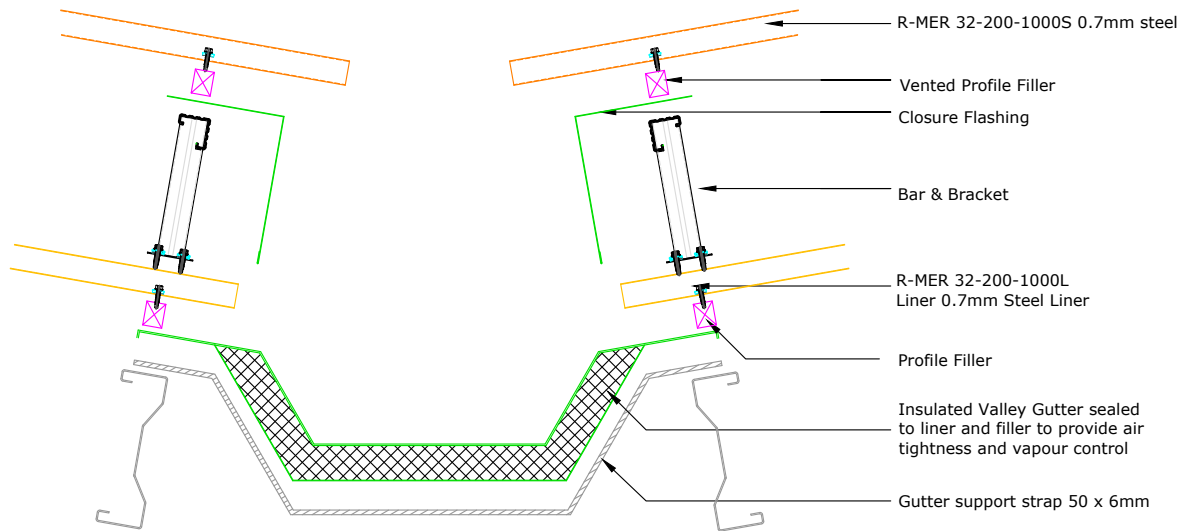

Insulation excluded for clarity

SITE:	DRAWING NO.		-	09/04/2020		The Garland Company UK Limited Second Way, Avonmouth, Bristol, BS11 8DF Tel: 01174 401050 Fax: 01174 401057 www.garlandukltd.co.uk
	TITLE:	NTS SCALE AT A4.	MF DRAWN.	- CHECKED.		
R-MER CLAD BUILT-UP ROOF SYSTEM - VALLEY GUTTER						NOTE: THIS DRAWING IS FOR GUIDANCE AND REFERENCE ONLY. TO BE USED IN CONJUNCTION WITH SPECIFICATION.

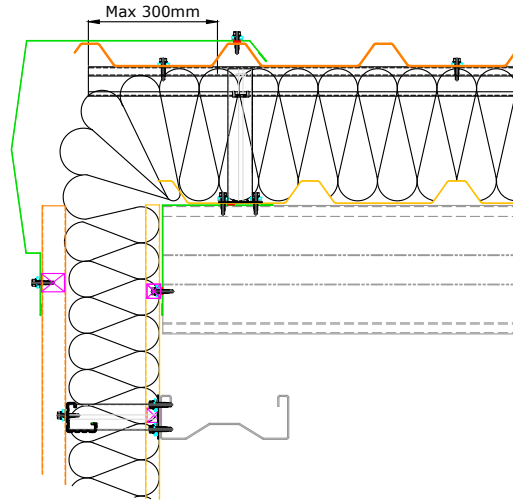

R-MER CLAD BUILT-UP SYSTEM ROOF CONSTRUCTION

R-MER CLAD BUILT-UP SYSTEM WALL V 1 CONSTRUCTION

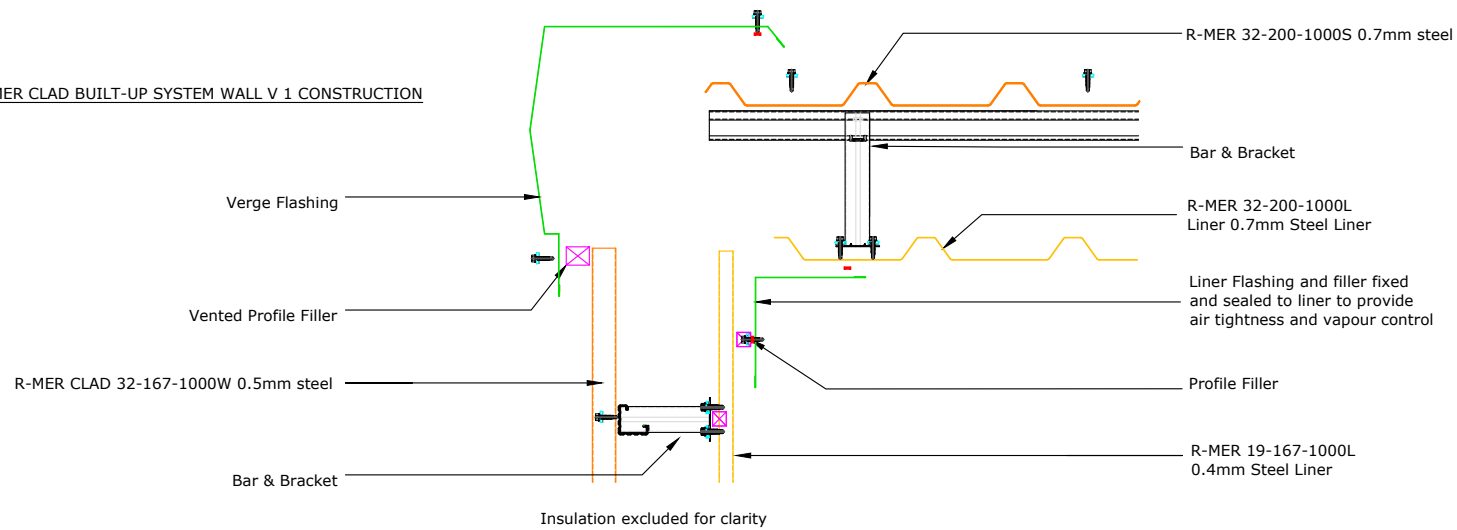

SITE:

DRAWING NO.

PROJECT NO.

09/04/2020

DATE.



The Garland Company UK Limited
 Second Way, Avonmouth, Bristol, BS11 8DF
 Tel: 01174 401050 Fax: 01174 401057
 www.garlandukltd.co.uk

TITLE:

R-MER CLAD BUILT-UP ROOF SYSTEM - VERGE

NTS
 SCALE AT A4.

MF
 DRAWN.

-
 CHECKED.

1.0
 REVISION.

NOTE: THIS DRAWING IS FOR GUIDANCE AND REFERENCE ONLY.
 TO BE USED IN CONJUNCTION WITH SPECIFICATION.

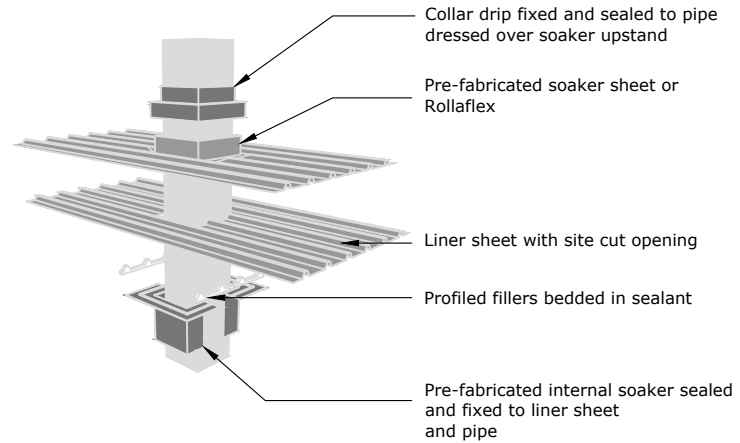
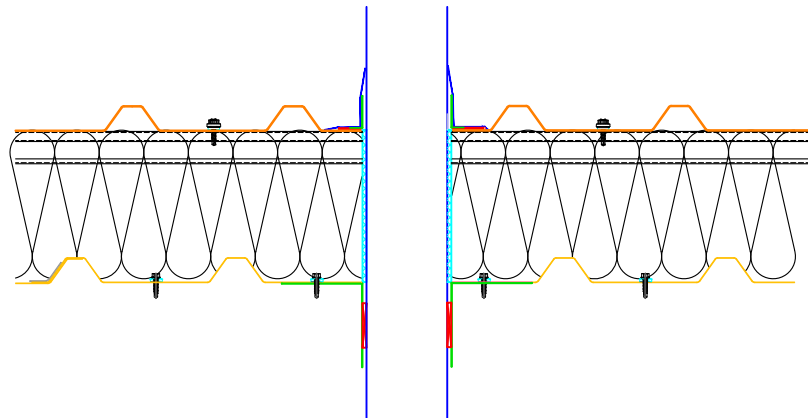

R-MER CLAD BUILT-UP SYSTEM ROOF CONSTRUCTION

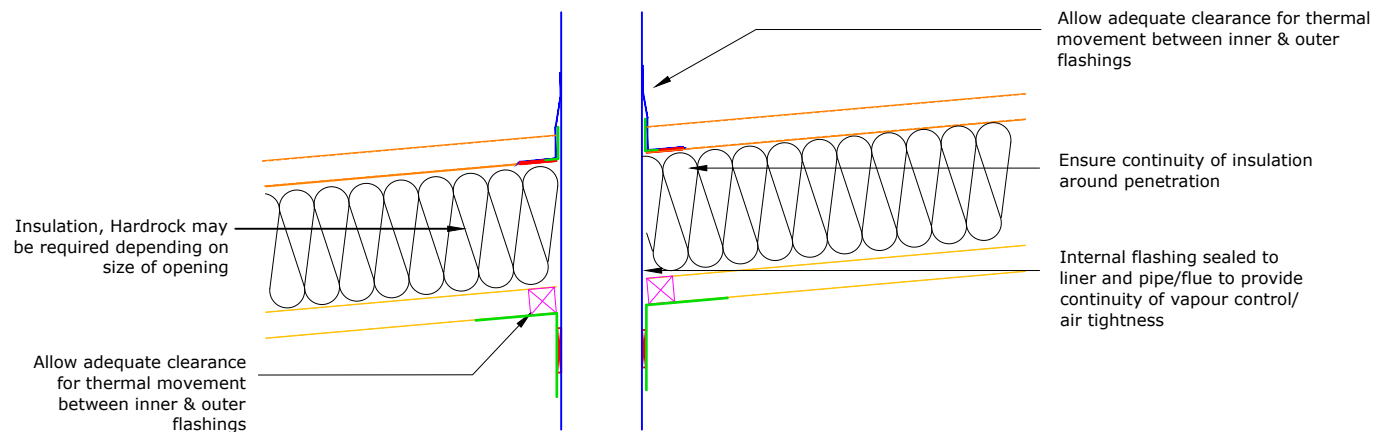

SITE:	DRAWING NO.		-	09/04/2020		The Garland Company UK Limited Second Way, Avonmouth, Bristol, BS11 8DF Tel: 01174 401050 Fax: 01174 401057 www.garlandukltd.co.uk
TITLE: R-MER CLAD BUILT-UP ROOF SYSTEM - PENETRATION	NTS SCALE AT A4.	MF DRAWN.	-	1.0 REVISION.		NOTE: THIS DRAWING IS FOR GUIDANCE AND REFERENCE ONLY. TO BE USED IN CONJUNCTION WITH SPECIFICATION.

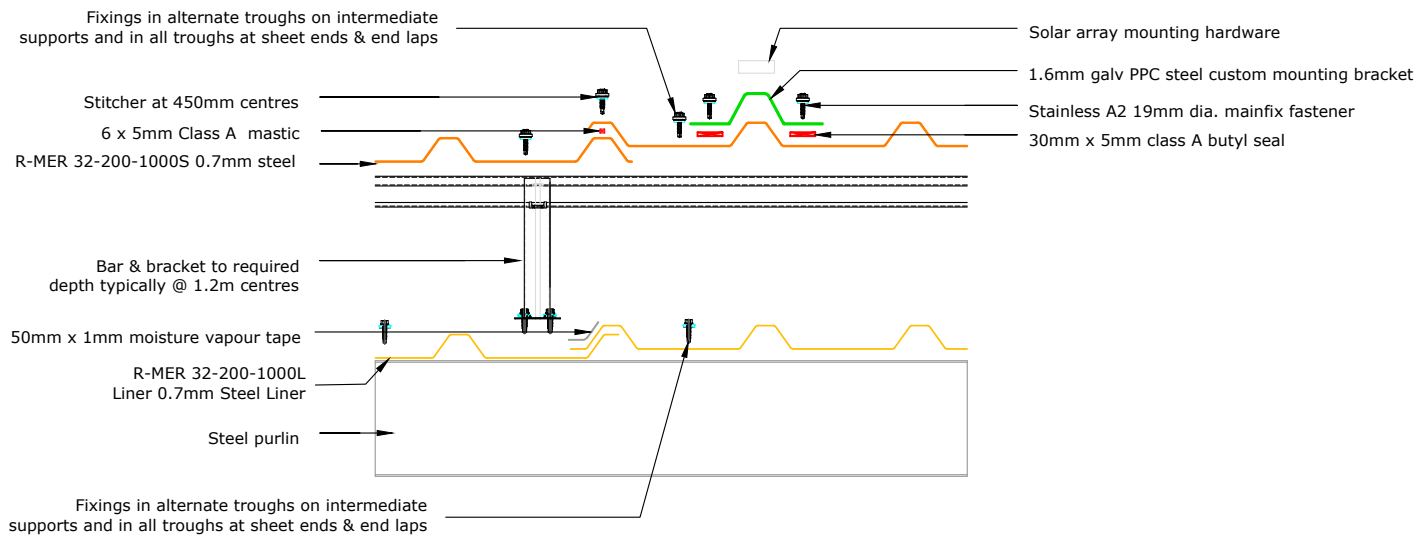
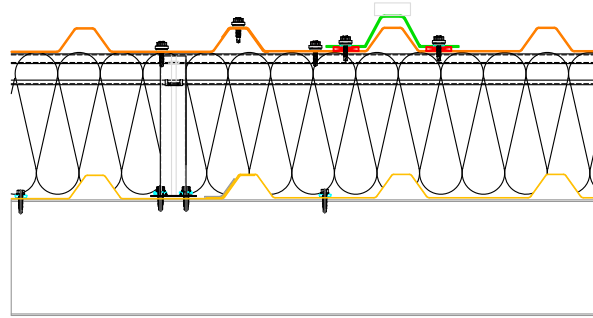

Insulation excluded for clarity

SITE:	DRAWING NO.		PROJECT NO.	DATE.		The Garland Company UK Limited Second Way, Avonmouth, Bristol, BS11 8DF Tel: 01174 401050 Fax: 01174 401057 www.garlandukltd.co.uk
TITLE: R-MER CLAD BUILT-UP ROOF SYSTEM - SOLAR BRACKET	NTS SCALE AT A4.	MF DRAWN.	- CHECKED.	09/04/2020 1.0 REVISION.		

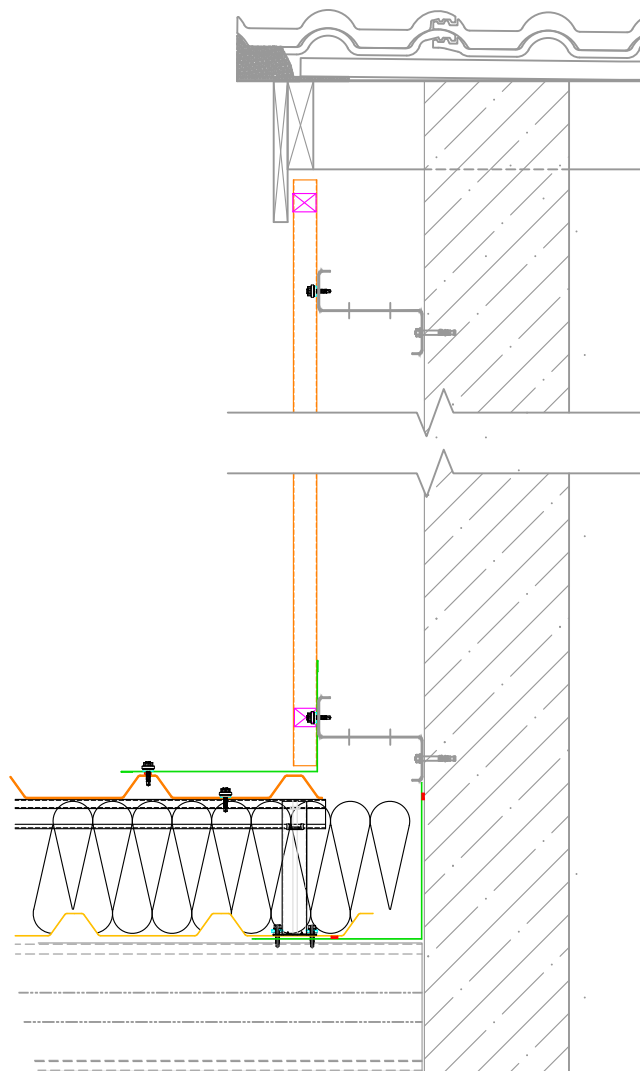

Gable end construction by others

Vented Profile Filler

R-MER CLAD BUILT-UP SYSTEM WALL V 1 CONSTRUCTION

Horizontal rail

R-MER CLAD BUILT-UP SYSTEM ROOF CONSTRUCTION

R-MER 32-167-1000W 0.5mm steel

Vented Profile Filler

External Flashing

9x3mm Mastic Sealant

R-MER 32-200-1000S 0.7mm steel

Bar & Bracket

R-MER 32-200-1000L
Liner 0.7mm Steel Liner

9x3mm Mastic Sealant

Horizontal rail

Large amount of sealant to make allowance for imperfection in wall and ensure good airtightness.

Liner Flashing sealed to abutment wall to provide air tightness and vapour control

Insulation excluded for clarity

SITE:

DRAWING NO.

PROJECT NO.

05/06/2020

DATE.



The Garland Company UK Limited
Second Way, Avonmouth, Bristol, BS11 8DF
Tel: 01174 401050 Fax: 01174 401057
www.garlandukltd.co.uk

TITLE:

R-MER CLAD BUILT-UP ROOF SYSTEM - GABLE END ABUTMENT

NTS
SCALE AT A4.

MF
DRAWN.

-
CHECKED.

1.0
REVISION.

NOTE: THIS DRAWING IS FOR GUIDANCE AND REFERENCE ONLY.
TO BE USED IN CONJUNCTION WITH SPECIFICATION.